

KENWOOD

CD PLAYER

DP-2060

DP-1060

INSTRUCTION MANUAL

KENWOOD CORPORATION

This manual contains instructions for two models.
Model availability and features (functions) may differ
depending on the country and sales area.

COMPACT
disc
DIGITAL AUDIO

Introduction

Your choice of this product indicates that you are a devotee to excellence in sound reproduction.

We appreciate your patronage and take pride in the long tradition of quality components that our company represents.

So that you can get the most out of your unit, we suggest that you take the time to read through this manual before you hook up and operate your system. This will acquaint you with operating features and system-connection considerations so that your listening pleasure will be enhanced right from the start. You will notice that in all aspects of planning, engineering, styling, operating convenience and adaptability we have sought to anticipate your needs and desires.

Keep this manual handy for future reference.

For your records

Record the serial number, found on the back of the unit, in the spaces designated on the warranty card, and in the space provided below. Refer to the model and serial numbers whenever you call upon your dealer for information or service on this product.

Model _____ Serial Number _____

Unpacking

Unpack the unit carefully and make sure that all accessories are put aside so they will not be lost.

Examine the unit for any possibility of shipping damage. If your unit is damaged or fails to operate, notify your dealer immediately. If your unit was shipped to you directly, notify the shipping company without delay. Only the consignee (the person or company receiving the unit) can file a claim against the carrier for shipping damage.

We recommend that you retain the original carton and packing materials for use should you transport or ship the unit in the future.

The marking of products using lasers (Except for some areas.)

**CLASS 1
LASER PRODUCT**

The label is attached to the rear panel and says that the component uses laser beams that have been classified as Class 1.

It means that the unit is utilizing laser beams that are of a weaker class. There is no danger of hazardous radiation outside the unit.

For the U.S.A.

CAUTION:

Use of controls or adjustments or performance of procedures other than those specified here in may result in hazardous radiation exposure.

In compliance with Federal Regulations, following are reproductions of labels on, or inside the product relating to laser product safety.

KENWOOD CORPORATION
2967-3, ISHIKAWA-CHO,
HACHIOJI-SHI,
TOKYO, JAPAN

KENWOOD CORP. CERTIFIES THIS EQUIPMENT
CONFORMS TO DHHS REGULATIONS NO. 21
CFR 1040.10, CHAPTER I, SUBCHAPTER J.

Location: Back Panel

Accessories

- Audio cord 1
- System control cord 1



- Remote control unit 1
(DP-2060 only)
- Batteries (R6/AA) 2
(DP-2060 only)

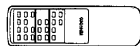

Contents

Caution: Read the pages marked Δ carefully to ensure safe operation.

Introduction	2
Special features	3
Δ Before applying power	3
Δ Safety precautions	3
Δ IMPORTANT SAFEGUARDS	4
Before operation	6
System connections	7
Controls and indicators	8

Remote control operation (DP-2060 only)	9
Normal playback (TRACK mode)	10
Programmed playback (PGM mode)	12
Editing (CCRS)	14
Repeated playback	16
Timer operations	17
In case of difficulty	18
Specifications	19

Special features

 **Caution: Read this page carefully to ensure safe operation.**

Programmed Playback Up to 20 of your favorite tunes can be programmed in any order you want and can be played back.

EDIT function This is an editing function that prevents the last tune on both sides A and B from being interrupted, within a stipulated time, when a CD is being recorded onto a cassette tape.

Before applying power

Units are designed for operation as follows.

- U.S.A. and Canada** 120 V only
U.K. and Australia 240 V only
Europe (Except for U.K.) 230 V only
* **Other countries** 110-120 / 220-240 V switchable

For the United Kingdom

Factory fitted moulded mains plug

1. The mains plug contains a fuse. For replacement, use only a 13-Amp ASTA-approved (BS1362) fuse.
2. The fuse cover must be refitted when replacing the fuse in the moulded plug.
3. Do not cut off the mains plug from this equipment. If the plug fitted is not suitable for the power points in your home, or the cable is too short to reach a power point, then obtain an appropriate safety approved extension lead or adaptor, or consult your dealer. If nonetheless the mains plug is cut off, remove the fuse and dispose of the plug immediately, to avoid a possible shock hazard by inadvertent connection to the mains supply.

* AC voltage selection

The AC voltage selector switch on the rear panel is set to the voltage that prevails in the area to which the unit is shipped. Before connecting the power cord to your AC outlet, make sure that the setting position of this switch matches your line voltage. If not, it must be set to your voltage in accordance with the following direction.

AC voltage selector switch

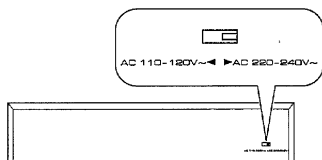

Move switch lever to match your line voltage with a small screwdriver or other pointed tool.

Note:

Our warranty does not cover damage caused by excessive line voltage due to improper setting of the AC voltage selector switch.

Safety precautions

WARNING: TO PREVENT FIRE OR ELECTRIC SHOCK, DO NOT EXPOSE THIS APPLIANCE TO RAIN OR MOISTURE.



CAUTION
RISK OF ELECTRIC SHOCK
DO NOT OPEN



CAUTION: TO REDUCE THE RISK OF ELECTRIC SHOCK, DO NOT REMOVE COVER (OR BACK). NO USER-SERVICEABLE PARTS INSIDE. REFER SERVICING TO QUALIFIED SERVICE PERSONNEL.



THE LIGHTNING FLASH WITH ARROWHEAD SYMBOL, WITHIN AN EQUILATERAL TRIANGLE, IS INTENDED TO ALERT THE USER TO THE PRESENCE OF UNINSULATED "DANGEROUS VOLTAGE" WITHIN THE PRODUCT'S ENCLOSURE THAT MAY BE OF SUFFICIENT MAGNITUDE TO CONSTITUTE A RISK OF ELECTRIC SHOCK TO PERSONS.



THE EXCLAMATION POINT WITHIN AN EQUILATERAL TRIANGLE IS INTENDED TO ALERT THE USER TO THE PRESENCE OF IMPORTANT OPERATING AND MAINTENANCE (SERVICING) INSTRUCTIONS IN THE LITERATURE ACCOMPANYING THE APPLIANCE.

IMPORTANT SAFEGUARDS

 **Caution: Read this page carefully to ensure safe operation.**

Please read all of the safety and operating instructions before operating this appliance. Adhere to all warnings on the appliance and in the instruction manual. Follow all the safety and operating instructions... These safety and operating instructions should be retained for future reference.

- 1. Power sources** – The appliance should be connected to a power supply only of the type described in the instruction manual or as marked on the appliance. If you are not sure of the type of power supply to your home, consult your appliance dealer or local power company. For appliances intended to operate from battery power, or other sources, refer to the instruction manual.
- 2. Power-cord protection** – Power-supply cords should be routed so that they are not likely to be walked on or pinched by items placed upon or against them, paying particular attention to cords at plugs, convenience receptacles, and the point where they exit from the appliance.

Never pull or stretch the cord.



- 3. CAUTION – Polarization** – This appliance may be equipped with a polarized alternating-current line plug (a plug having one blade wider than the other). This plug will fit into the power outlet only one way. This is a safety feature. If you are unable to insert the plug fully into the outlet, try reversing the plug. If the plug should still fail to fit, contact your electrician to replace your obsolete outlet. Do not defeat the safety purpose of the polarized plug.

- 4. Ventilation** – Slots and openings in the cabinet are provided for ventilation and to ensure reliable operation of the appliance and to protect it from overheating, and these openings must not be blocked or covered. The appliance should be situated so that its location or position does not interfere with its proper ventilation.

To maintain good ventilation, do not put records or a tablecloth on the appliance. Place the appliance at least 10 cm away from the walls.

Do not use the appliance on a bed, sofa, rug or similar surface that may block the ventilation openings. This appliance should not be placed in a built-in installation such as a bookcase or rack unless proper ventilation is provided or the manufacturer's instructions have been adhered to.

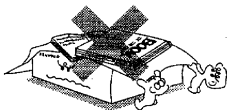

- 5. Water and moisture** – The appliance should not be used near water - for example, near a bathtub, washbowl, kitchen sink, laundry tub, in a wet basement, or near a swimming pool, etc.

- 6. Temperature** – The appliance may not function properly if used at extremely low, or freezing temperatures. The ideal ambient temperature is above +5°C (41°F).
- 7. Heat** – The appliance should be situated away from heat sources such as radiators, heat registers, stoves, or other appliances (including amplifiers) that produce heat.
- 8. Electric shock** – Care should be taken so that objects do not fall and liquid is not spilled into the enclosure through openings. If a metal object, such as a hair pin or a needle, comes into contact with the inside of this appliance, a dangerous electric shock may result. For families with children, never permit children to put anything, especially metal, inside this appliance.



- 9. Enclosure removal** – Never remove the enclosure. If the internal parts are touched accidentally, a serious electric shock might occur.

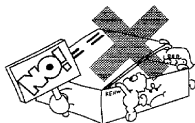

- 10. Magnetic fields** – Keep the appliance away from sources of magnetic fields such as TV sets, speaker systems, radios, motorized toys or magnetized objects.

- 11. Cleaning** – Unplug this appliance from the wall outlet before cleaning. Do not use volatile solvents such as alcohol, paint thinner, gasoline, or benzene, etc. to clean the cabinet. Use a clean dry cloth.

- 12. Accessories** – Do not place this appliance on an unstable cart, stand, tripod, bracket, or table. The appliance may fall, causing serious injury to a child or adult, and serious damage to the appliance. Use only with a cart, stand, tripod, bracket, or table recommended by the manufacturer, or sold with the appliance. Any mounting of the appliance should follow the manufacturer's instructions, and should use a mounting accessory recommended by the manufacturer. An appliance and cart combination should be moved with care. Quick stops, excessive force, and uneven surfaces may cause the appliance and cart combination to overturn.



13. Lightning – For added protection for this appliance during a lightning storm, or when it is left unattended and unused for long periods of time, unplug it from the wall outlet and disconnect the antenna or cable system. This will prevent damage to the appliance due to lightning and power-line surges.

14. Abnormal smell – If an abnormal smell or smoke is detected, immediately turn the power OFF and unplug the appliance from the wall outlet. Contact your dealer or nearest service center.

POWER OFF!

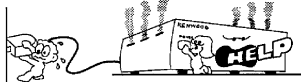

15. Damage requiring service – The appliance should be serviced by qualified service personnel when:

- A.** The power-supply cord or the plug has been damaged.
- B.** Objects have fallen, or liquid has been spilled into the appliance.
- C.** The appliance has been exposed to rain or water.
- D.** The appliance does not appear to operate normally by following the instruction manual. Adjust only those controls that are covered by the instruction manual as an improper adjustment of other controls may result in damage and will often require extensive work by a qualified technician to restore the appliance to its normal operation.
- E.** The appliance has been dropped, or the enclosure damaged.
- F.** The appliance exhibits a marked change in performance.

16. Servicing – The user should not attempt to service the appliance beyond that described in the instruction manual. All other servicing should be referred to qualified service personnel.

17. Outdoor antenna grounding – If an outside antenna is connected to the appliance, be sure the antenna system is grounded so as to provide some protection against voltage surges and built up static charges. Article 810 of the National Electrical Code (ANSI/NFPA 70), provides information with respect to proper grounding of the mast and supporting structure, grounding of the lead-in wire to an antenna discharge unit, size of grounding conductors, location of antenna discharge unit, connection to grounding electrodes, and requirements for the grounding electrode. See Figure.

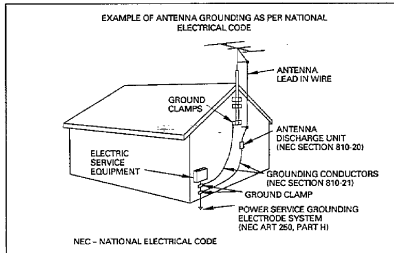

18. Power lines – An outside antenna system should not be located in the vicinity of overhead power lines or other electric light or power circuits, or where it can fall into such power lines or circuits. When installing an outside antenna system, extreme care should be taken to keep from touching such power lines or circuits as contact with them might be fatal.

19. AC outlets – Do not connect other audio equipment with a power consumption larger than that specified to the AC outlet on the rear panel. Never connect other electrical appliances, such as an iron or toaster, to it to prevent fire or electric shock.

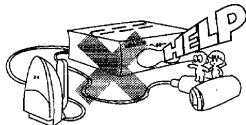

20. Overloading – Do not overload wall outlets, extension cords, or integral convenience receptacles as this can result in a risk of fire or electric shock.

21. Attachment – Do not use attachments not recommended by the appliance manufacturer as they may cause hazards.

22. Replacement parts – When replacement parts are required, be sure the service technician has used replacement parts specified by the manufacturer or have the same characteristics as the original parts. Unauthorized substitutions may result in fire, electric shock, or other hazards.

23. Safety check – Upon completion of any service or repairs to this appliance, ask the service technician to perform safety checks to determine that the appliance is in proper operating condition.

Notes:

- 1. Item 3 is not required except for grounded or polarized equipment.
- 2. Item 17 and 18 are not required except for units provided with antenna terminals.
- 3. Item 17 complies with UL in the U.S.A.

Before operation

Disc handling precautions

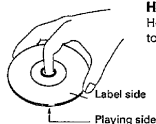

Handling

Hold compact discs so that you do not touch the playing surface.

Do not attach paper or tape to either the playing side or the label side of compact discs.

Caution on disc used

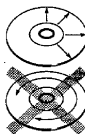

Cleaning

If fingerprints or foreign matter become attached to the disc, lightly wipe the disc with a soft cotton cloth (or similar) from the center of the disc outwards in a radial manner.



Storage

When a disc is not to be played for a long period of time, remove it from the CD player and store it in its case.

Never play a cracked or warped disc.

During playback, the disc rotates at high speed in the player. Therefore, to avoid danger, never use a cracked or deformed disc or a disc repaired with tape or adhesive agent.

Note related to transportation and movement

Before transporting or moving the CD PLAYER, carry out the following operations.

1. Turn the power ON but do not load a disc.
2. Wait a few seconds and verify that the display shown appears.
3. Turn the power OFF.

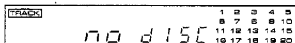

Beware of condensation

When water vapor comes into contact with the surface of cold material, water drops are produced.

If condensation occurs, correct operation may not be possible, or the unit may not function correctly.

This is not a malfunction, however, the unit should be dried. (To do this, turn the POWER switch ON and leave the unit as it is for several hours.)

Be especially careful in the following conditions:

- When the unit is brought from a cold place to a warm place, and there is a large temperature difference.
- When a heater starts operating.
- When the unit is brought from an air-conditioned place to a place of high temperature with high humidity.
- When there is a large difference between the internal temperature of the unit and the ambient temperature, or in conditions where condensation occurs easily.

System connections

Make connections as shown below. When connecting the related system components, refer also to the instruction manuals of the related components.

Do not plug in the power lead until all connections are completed.

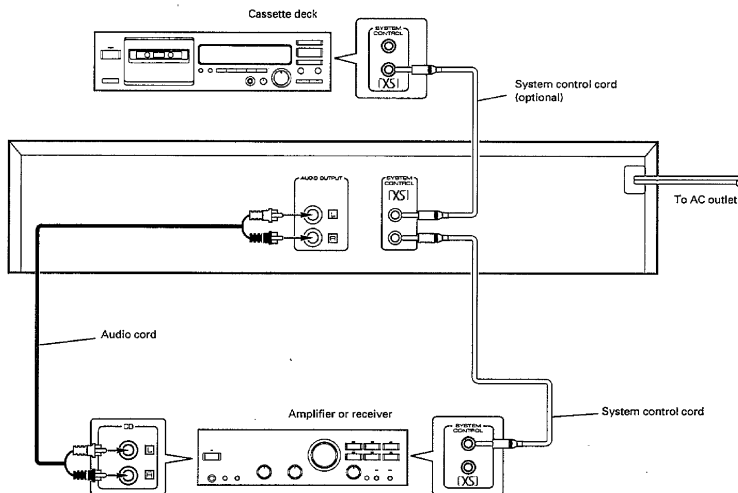

CCRS

By connecting the SYSTEM CONTROL terminal of this unit with the "XS1/XSBI" SYSTEM CONTROL terminal of a KENWOOD cassette deck, CCRS recording can be carried out.

The CCRS function is used when recording from a CD to a tape in a cassette deck, and operates to adjust the cassette deck's recording level to the optimum setting according to the playing level of the CD. For details on the CCRS function, refer to the instruction manual provided with your cassette deck.

System control connection

When connected to an amplifier or receiver having KENWOOD SYSTEM CONTROL terminals, system operation such as remote control is made possible. For details, refer to the instruction manual of the amplifier or receiver.

If your amplifier or receiver is not equipped with the SYSTEM CONTROL terminals, do not connect anything to any SYSTEM CONTROL terminals.

Do not connect the unit in any system configuration other than specified.

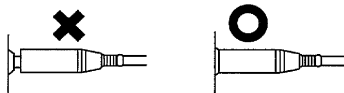

- Be sure to insert the system control cord plugs fully into the SYSTEM CONTROL terminals.
- If the system control cord and audio cords are not connected properly, the automatic system governing remote control and system functions will not operate.

Notes:

1. Connect all cords firmly. If connections are loose, there could be loss of sound or noise produced.
2. When plugging and unplugging connection cords, be sure to first remove the power cord from the AC outlet.

Plugging/unplugging connection cords without removal of the power cord can cause malfunctions or damage to the unit.

Controls and indicators

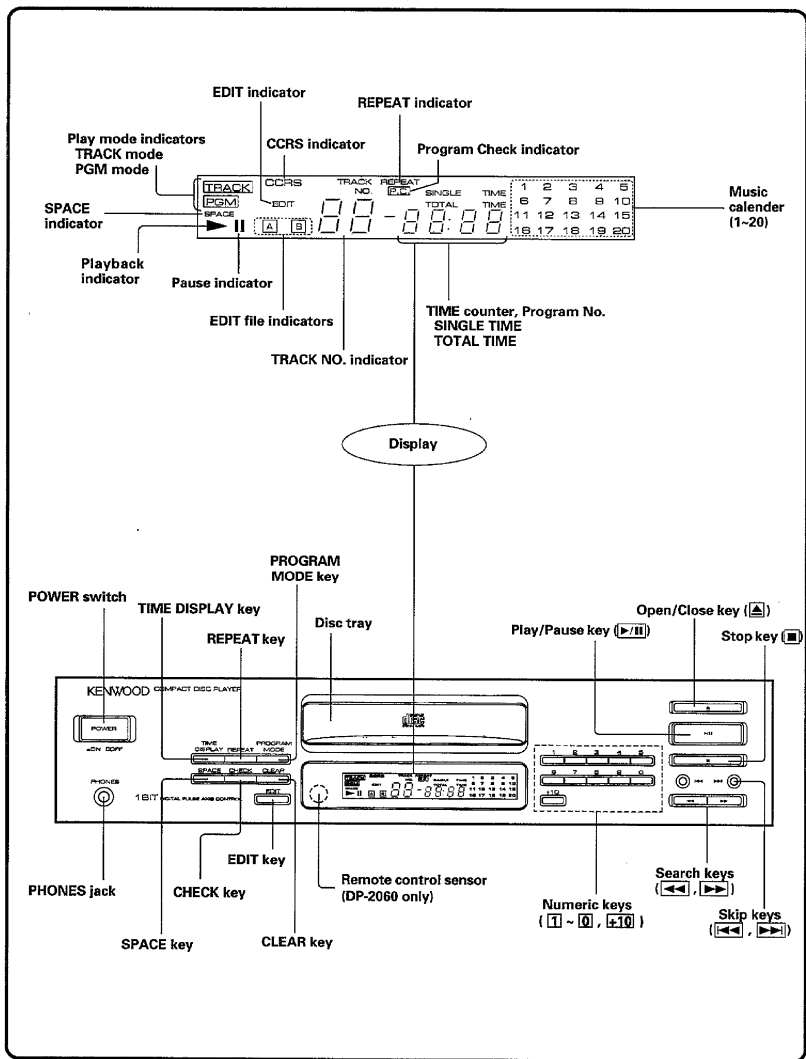

Remote control operation (DP-2060 only)

The operations of each are the same as those of the keys in the unit.

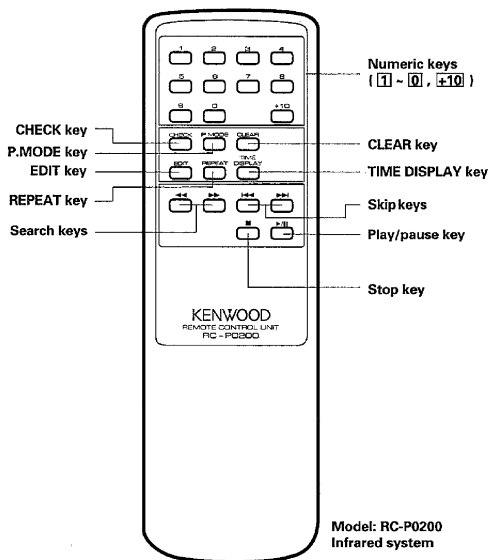

■ Loading batteries

1 Remove the cover.

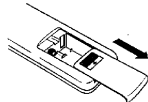

2 Insert batteries.

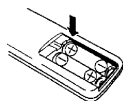

Insert two batteries (R6/AA) as indicated by the polarity marking.

3 Close the cover.

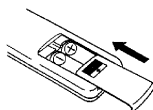

■ Operating procedure

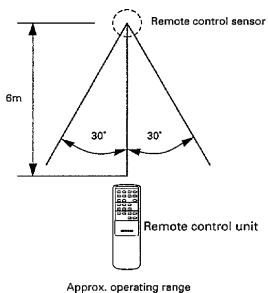

- When two operation keys on the remote control unit are pressed successively, press each key securely reserving an interval of more than 1 second for each press.

Notes:

- The supplied batteries are intended for use in operation checks. Therefore, their lives may be shorter than ordinary batteries.
- When the remote-controllable distance gets shorter than before, replace both batteries with new ones.
- Malfunction may occur if direct sunlight or the light of a high-frequency lighting fluorescent lamp enters the remote control light sensor. In such a case, change the system installation position to prevent the malfunction.

Normal playback (TRACK mode)

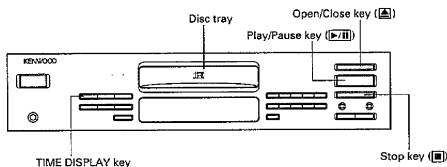

■ Playing a CD from the beginning (TRACK mode)

1 Press the POWER key to ON.

2 Load a CD.

① Open the disc tray.

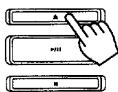

② Place a disc on the tray.

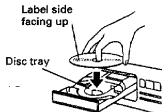

- Hold the disc with care not to touch the side to be played.
- Be sure to place only one CD at a time.

③ Close the tray.

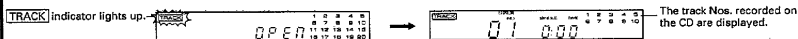
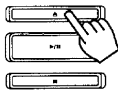

3 Start playback.

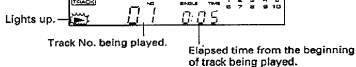
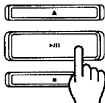

- In a few seconds, playback starts from track No. 1.

To pause CD play

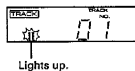
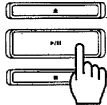

- To resume playback, press the ▶/II key again.

To stop CD play

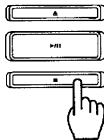

TIME DISPLAY key

Press the **TIME DISPLAY** key when you want to check the elapsed time and remaining time of the track being played. Every time the **TIME DISPLAY** key is pressed, the displayed time changes as shown below.

The time information display may not appear when playing a CD containing 44 or more tracks. In such a case, the display (remaining SINGLE TIME) will show "----".

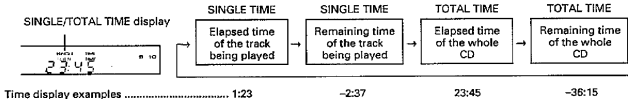

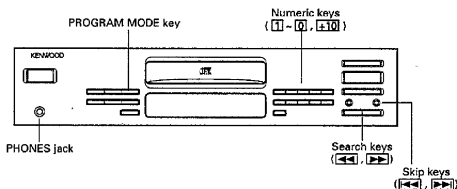

■ Listening from the desired track

Select with the skip key.

Press one of the skip (◀◀, ▶▶) keys according to the direction to skip.

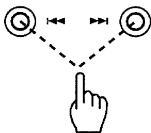

- The tunes are skipped in the direction of the key and the play starts at the beginning of the selected tune.
- When the [◀◀] key is pressed once during play, the track starts again from the beginning.

Select with the search key.

Press the forward (▶▶) or reverse (◀◀) search key according to the direction to search.

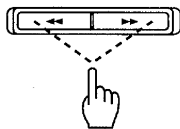

- The track will start to play from where you release the key.

Select with the numeric keys.

- 1 Ensure that the CD player is in the TRACK mode.

TRACK indicator Lights up.

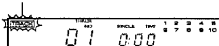

- If the [PGM] indicator is lighted, press the [PROGRAM MODE] key.

- 2 Select the desired track.

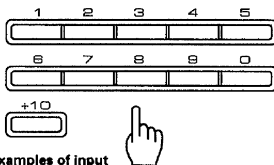

Examples of input

Track No. 23: +10 +10 3

Track No. 40: +10 +10 +10 +10 0

- Play starts from the selected tune and after.

Notes:

1. If a track No. which is not present on the CD is selected while the tray is open, the last track on the CD will be played.
2. Such a selection is not accepted after the tray has been closed or playback has started.

To use the headphone

Connect commercially-available stereo headphones to the PHONES jack for private listening.



Programmed playback (PGM mode)

Up to 20 tunes can be programmed in the desired order and can be played.

■ Playing desired tracks in desired order (PGM mode)

1 Enter the PGM mode.

Press the **PROGRAM MODE** key.

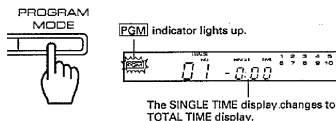

2 Program desired tracks in desired order.

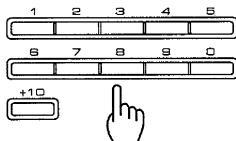

Example

To program track Nos. 2, 5 and 25:

2 5 10 15

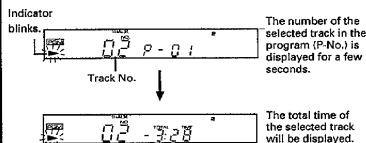

- Up to 20 tracks can be programmed. FULL is displayed if you attempt to program the 21st track.
- If you made a mistake, press the **CLEAR** key and select the correct track.
- Tracks can be also programmed by reading the disc label while the disc tray is open.
- The time information is not displayed if a track No. of 44 or more is programmed.

3 Start playback.

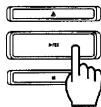

- Tracks are played in the order they are programmed (P.No.).
- If one of the skip keys (▶ or ◀) is pressed during programmed playback, the track being played is skipped in the forward or reverse direction.

To check the programmed contents

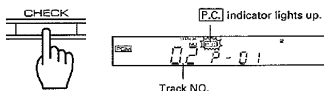

- Every time the **CHECK** key is pressed, the track No. and the contents which were programmed (P.No.) are displayed in the order of programming.
- The previous display will resume in a few seconds.

To resume normal playback

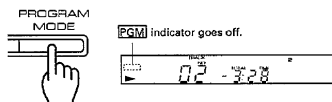

- The playback in the order of the track Nos. on CD will start after the track which is being played.

To stop programmed playback

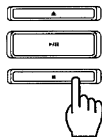

To check the time of each track on the disc

In the program mode, when the disc is stopped, the time of each track on the disc can be checked by pressing the skip keys ▶▶ or ◀◀.

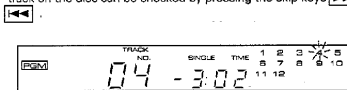

- The previous display will resume in a few seconds.

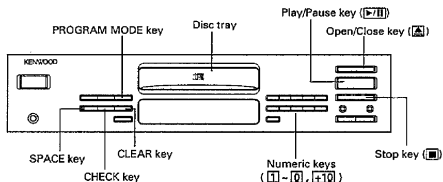

■ To add a track to the program

Press the key(s) for the track No. to be added.

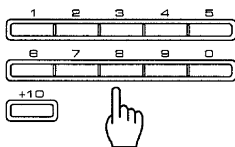

■ To clear tracks from the program

Clearing from the last track



- Every time the key is pressed, tracks are cleared from the last track in order.

■ To change a track in the program

1 Press the CHECK key.

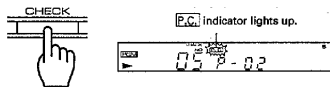

- Press until the P-No. to be changed is displayed.

Clearing the whole of program

Press either of these keys.

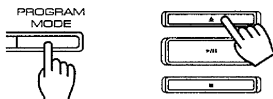

2 Select the track No. to replace the previous one.

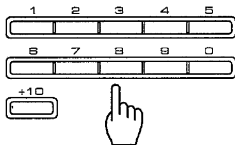

Press while the P.C. indicator is lighted.

- The track which is being played cannot be changed.

Auto-Space function

During playback in the program mode, when the **SPACE** key is pressed, a space of about 4 seconds is reserved automatically between the programmed tracks. This function is provided to facilitate the DPSS function of a KENWOOD's cassette deck. However, such a space could also be reserved in case the sound of two tracks are continued, for example with some classic music and live recordings.

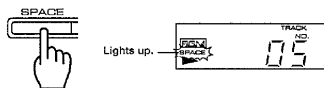

- The total time is displayed including the time of the space.
- To cancel Auto-Space function, press the **SPACE** key again.

Editing (CCRS)

This function is for editing when you are recording the contents of a CD onto a tape. It is to ensure that the final track on each side of the tape is fully recorded and that the possible recording time on the tape will be fully used.

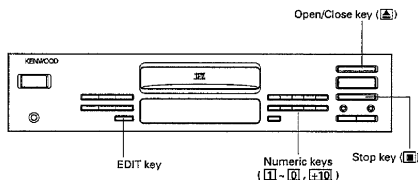

EDIT

Operate in the stop mode.

1 Select the EDIT mode.



EDIT indicator lights up.

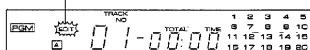

- Proceed to the step 2 while the EDIT indicator is lighted.

2 While the EDIT indicator is lighted, input the two-way recording time of the tape.

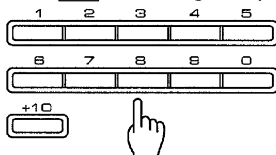

Example

For C-46 : +10 +10 +10 +10 6

For C-30 : +10 +10 +10 0

- Recording within 99 minutes can be specified in minutes (2 digits).

- When the EDIT operation is carried out after a designated tune is programmed, the programmed tune is given priority and then other tunes are added to the program in the order of their track numbers according to the amount of time remaining.

During editing

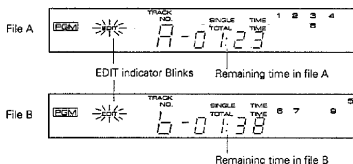

The CD contents are edited as follows.

- The input tape recording time is divided by two, and tracks that can be accommodated in file A (which refers to tracks on tape side A) are selected in order of their track Nos.
 - In a few seconds, the time left on tape side A is displayed, then file B (tracks on tape side B) is edited in the same manner.
- Editing will be interrupted if the [] or [] key is pressed during editing.

Completion of editing

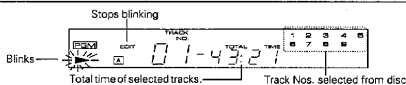

Recording edited data

Connecting the CD player via a system control cable to a KENWOOD cassette deck with an "DS1/XS8" designation will enable "CCRS recording".

For details, see "How to Record CD" in the instruction manual of the cassette deck.

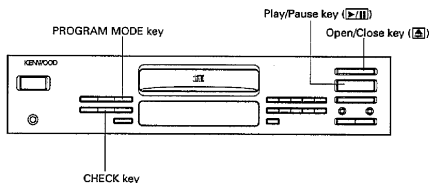

■ To check the edited contents

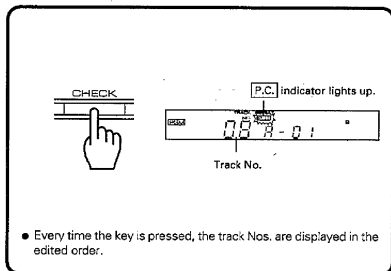

■ To clear the edited contents

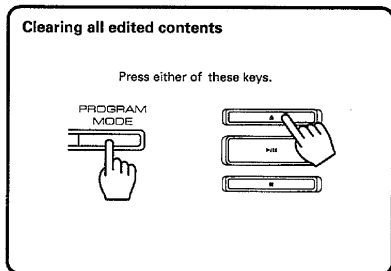

■ To play an edited program

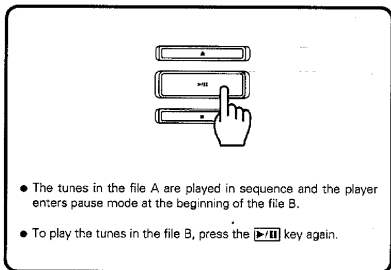

■ Activating EDIT SHUFFLE

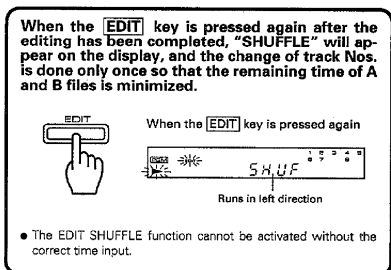

Notes:

1. While you can edit with a different time setting to that of the tape you are using, part of the tape may be left with nothing recorded on it, or the last track on side A or side B may be cut short.
2. Up to a maximum of 20 tracks can be edited using this function.
3. The EDIT function may not operate properly for discs having only one track or having tracks of long duration such as classical music.

Repeated playback

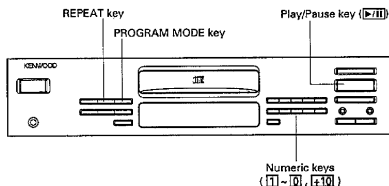

Repeated playback

Repeated playback of programmed tracks

1 Enter the PGM mode.

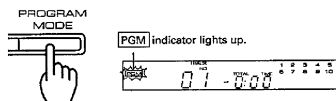

2 Select the desired track(s).

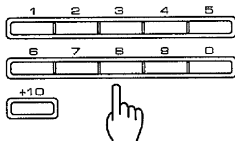

- All of the selected tracks will be played repeatedly.
- If only one track is selected, that track will be played repeatedly.

3 Press the REPEAT key.



4 Start playback.

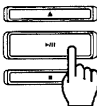

Repeated playback of the whole CD

1 Enter the TRACK mode.

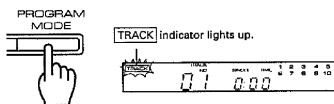

2 Press the REPEAT key.

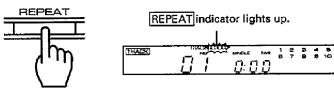

3 Start playback.

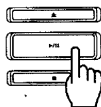

To resume normal playback

Press the **REPEAT** key again.



REPEAT indicator goes off.

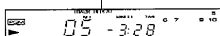

- The playback will be resumed under the CD player mode set before the repeat.

Timer operations

The unit has the timer stand-by function.

With this function and a commercially-available audio timer, playback can be started at the desired time.

1 Connect the power cord.

- Connect each unit's power cord to the SWITCHED outlet of the timer.
- Refer to the instruction manual of the timer.

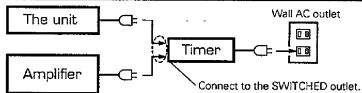

2 Turn on the amplifier and the unit.

3 Insert a disc and set the starting time of the timer.

- Set the timer while the unit and the amplifier are ON.
- Be careful of the volume setting of the amplifier. (The loud sound may damage the speakers.)

Playback will start at the set time.

Note:

When operating the unit other than CD player using an audio timer, be sure to remove the disc from the CD player.

In case of difficulty

What appears to be a malfunction may not always be serious. If your unit should not perform as expected, consult the table below to see if the problem can be corrected before seeking help from your dealer or service representative.

Symptom	Cause	Remedy
Disc is loaded, player does not play.	<ul style="list-style-type: none">● Disc is loaded upside down.● Disc is loose.● Disc is dirty.● Disc is cracked.● Condensation occurred on the optical lens unit.	<ul style="list-style-type: none">● Load the disc again with its label side up.● Insert the disc properly.● Wipe off the dust on the surface of the disc referring to "Disc handling precautions".● Replace the disc with a new one.● Leave the player for about 1 hour so that the condensation is removed.
No sound.	<ul style="list-style-type: none">● Disc is not loaded.● Disc is too dirty.● Disc is cracked.● The connection cords are inserted loosely.	<ul style="list-style-type: none">● Load a disc.● Wipe off the dust on the disc surface referring to "Disc handling precautions".● Replace the disc with a new one.● Connect all connection cords firmly.
Music is interrupted. (Sound is skipped.)	<ul style="list-style-type: none">● Disc is too dirty.● Disc is cracked.● Oscillation is applied to this unit.	<ul style="list-style-type: none">● Wipe off the dust on the disc surface referring to "Disc handling precautions".● Replace the disc with a new one.● Try selecting a place where no strong vibrations occur by changing the installation place, etc.

Notes:

1. This system is microprocessor-controlled, so malfunction may occur due to external noise or interference noise. In such a case, unplug the power cord, plug it and turn power on again.
2. Do not use contact cleaners because it could cause a malfunction. Be specially careful against contact cleaners containing oil, for they may deform the plastic components.

Specifications

[Format]

System Compact disc digital audio system
Laser Semiconductor laser
Number of channels 2 channels
playing rotation 200 rpm - 500 rpm (CLV)

[D/A Convertors]

D/A Conversion 1 Bit
Oversampling 8 fs (352.8 kHz)

[Audio]

Frequency response 8 Hz ~ 20 kHz \pm 1.0 dB
Signal to noise ratio More than 94 dB
Dynamic range More than 92 dB
Total harmonic distortion Less than 0.005%

Channel separation More than 83 dB
Wow & flutter Unmeasurable limit
Output level/impedance
Fixed 2.0V/3.3k Ω
Headphone output 6mW (32 Ω)

[General]

Power consumption 12W
Dimensions W: 440 mm (17 - 5/16")
H: 106 mm (4 - 3/16")
D: 310 mm (12 - 3/16")
Weight (Net) 3.8 kg (8.4 lb)

Note:

KENWOOD follows a policy of continuous advancements in development. For this reason specifications may be changed without notice.

For the U.S.A. FCC WARNING

This equipment may generate or use radio frequency energy. Changes or modifications to this equipment may cause harmful interference unless the modifications are expressly approved in the instruction manual. The user could lose the authority to operate this equipment if an unauthorized change or modification is made.

NOTE

This equipment has been tested and found to comply with the limits for a Class B digital device, pursuant to Part 15 of the FCC Rules. These limits are designed to provide reasonable protection against harmful interference in a residential installation. This equipment may cause harmful interference to radio communications, if it is not installed and used in accordance with the instructions. However, there is no guarantee that interference will not occur in a particular installation. If this equipment does cause harmful interference to radio or television reception, which can be determined by turning the equipment off and on, the user is encouraged to try to correct the interference by one or more of the following measures:

- Reorient or relocate the receiving antenna.
- Increase the separation between the equipment and receiver.
- Connect the equipment into an outlet on a circuit different from that to which the receiver is connected.
- Consult the dealer or an experienced radio/TV technician for help.

KENWOOD